

MODUL

DESIGN | QUALITY | ENVIRONMENT



benithem®



DESIGN INSPIRATION
The design has been derived from the structural design of a building, a complex and solid structure, which we simplified to build the MODUL. Solid and slender aluminum legs matched with the exquisite finishing of dull chrome, is the most prominent feature of the MODUL.

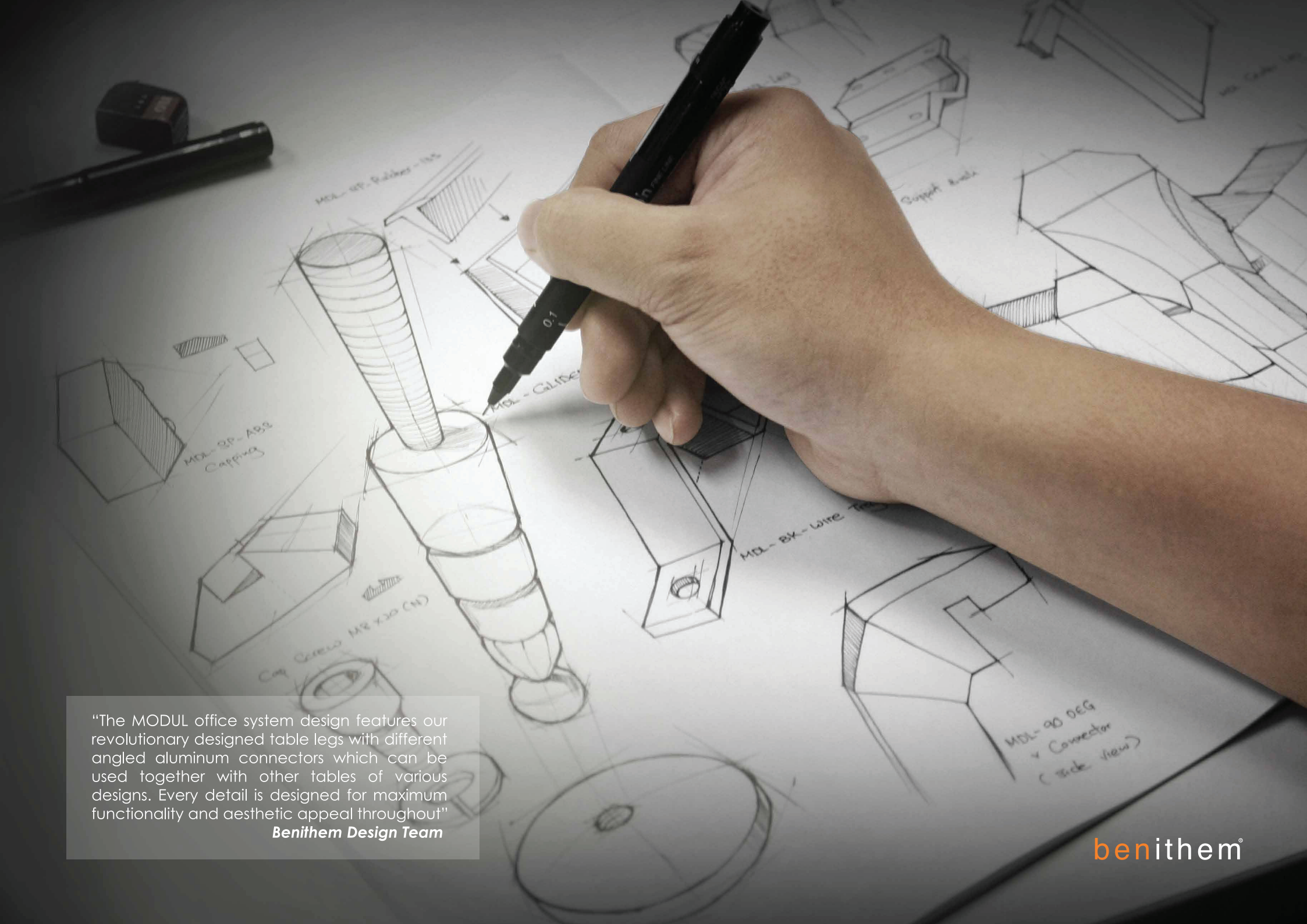

“The MODUL office system design features our revolutionary designed table legs with different angled aluminum connectors which can be used together with other tables of various designs. Every detail is designed for maximum functionality and aesthetic appeal throughout”

Benithem Design Team

MODUL WORKSTATION

Clean and simple aesthetics combined with a rich material vocabulary creates an appealing office landscape enlivened by the creative use of vibrant colors and varied textures. Design details such as the elegant Dull Chrome finishing Table Leg and Steel Beam, endow the furniture with a level of refinement that approaches that of high-end office furnishings.

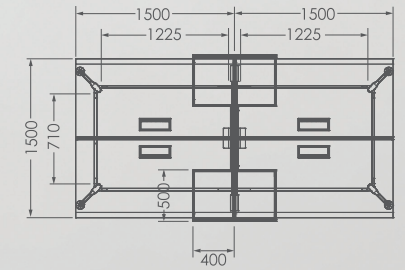

Tables Surface: White
Leg: Dull Chrome
Accessories: Acrylic Screen Panel
Storage: MDL-Steel Pedestal PM009
Cushion Top: MDL-Cushion Top 500*400
Task seating: Body
Panel Height: 350mm (from table top)
1100mm (from floor)

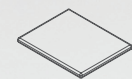

W 400
D 500
H 25



W 400
D 500
H 600

MODUL WORKSTATION

benithem®

Modul can be built up, out or in any direction to fit the space and style. Modul also gives people the ability to organize their space with caddy file cabinets and steel mobile pedestals that can be used as a seat and for storage.

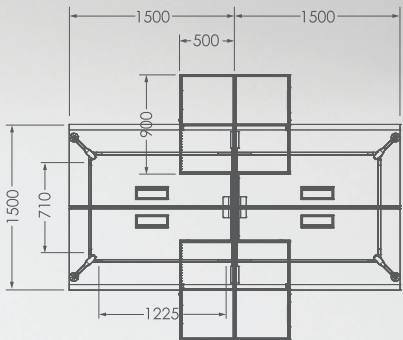

Tables Surface: White
Leg: Dull Chrome
Accessories: Acrylic Screen Panel
Storage: MDL-Caddy PM007
Cushion Top: MDL-Cushion Top 500*400
Task seating: Body
Panel Height: 350mm (from table top)
 1100mm (from floor)

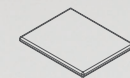

W 400
 D 500
 H 25

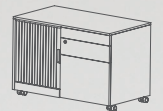

W 900
 D 500
 H 600

MODUL WORKSTATION

benithem®

A truly unique workstation solution, Modul integrates a full complement of desks, steel pedestals, caddies and screens. Every element falls into place and fits together perfectly, offering fresh design concepts.

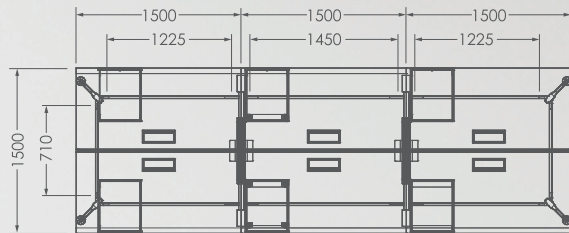

Tables Surface: White
Leg: Silver
Accessories: Fabric Screen Panel & Modesty Panel
Storage: MDL-Steel Pedestal PM009
Cushion Top: MDL-Cushion Top 500*400
Panel Height: 350mm (from table top)
1100mm (from floor)

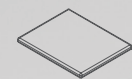

W 400
D 500
H 25



W 400
D 500
H 600

MODUL WORKSTATION

Modul offers a wide variety of color and texture options including melamine faced chipboards (MFC), fabric panels and matt finished acrylic panels. The rich material choice provides an opportunity to colorize the office environment.

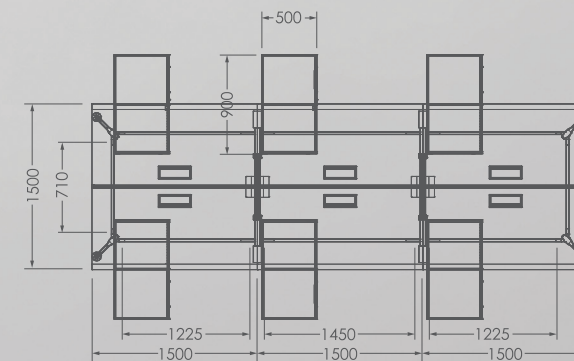

Tables Surface: White
Leg: Silver
Accessories: Fabric Screen Panel
Storage: MDL-Caddy PM007
Cushion Top: MDL-Cushion Top 500*400
Task Seating: Curve
Panel Height: 350mm (from table top)
 1100mm (from floor)

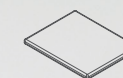

W 400
 D 500
 H 25



W 900
 D 500
 H 600

MODUL WORKSTATION

Accent colors, which energizes a space as well as various colors, can be applied to the cushion on top of the storage units. Fabric screen panels identify and distinguish work areas and enliven the office landscape.

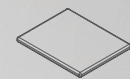
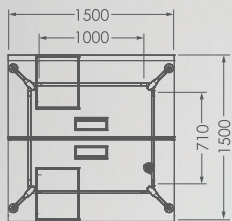

W 400
D 500
H 25



W 400
D 500
H 600

MODUL
WORKSTATION
 Optional Components



Cable Snake (CS)
 * Use for Cluster 2 only



Wire Console (WC)
 * Use for - Cluster 4,6 & 8

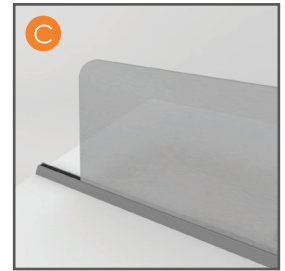

Acrylic Screen Panel (A)

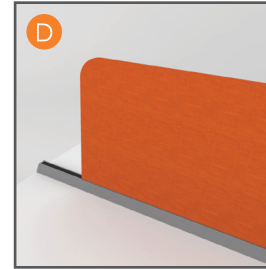

Fabric Screen Panel (F)



**Wire Tray Include
 Tray Power Point (WTT)**
 *Use for normal power socket.

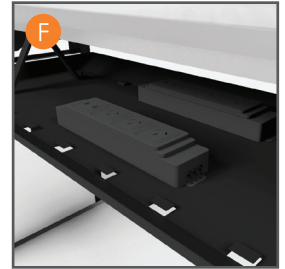

Wire Tray (WT)
 * Use for Netbox M

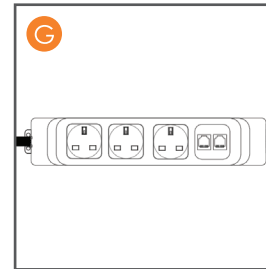
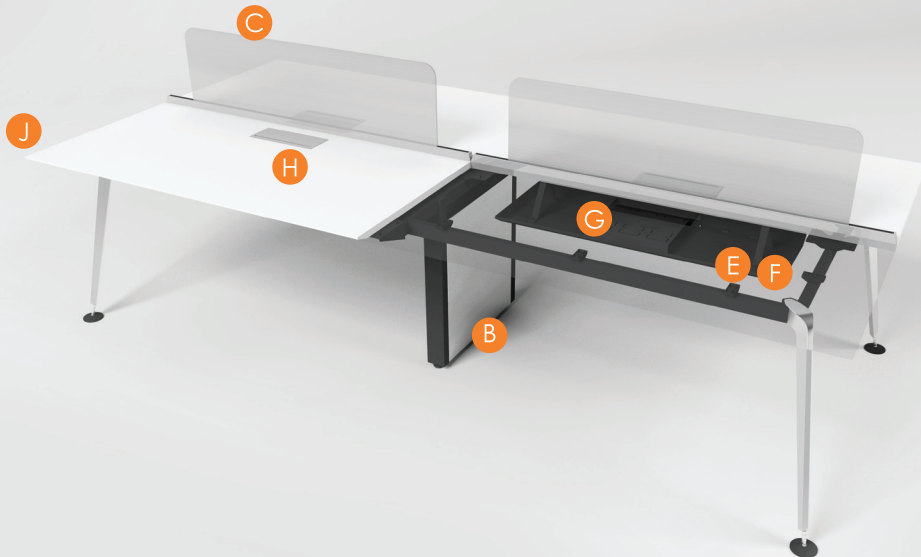

Netbox M
 (3 power socket + 1 Data
 + 1 Tel) **(NA-ND)**
 * Available for standard Great
 Britain **(NA)**, China **(NB)**, Australia
(NC), Japan/Philippines **(ND)**

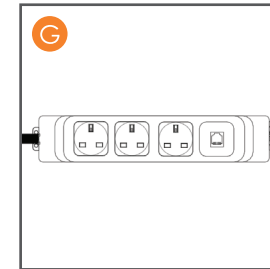

Netbox M
 (3 power socket + 1
 Data)
(NE-NH)
 * Available for standard Great
 Britain **(NE)**, China **(NF)**, Australia
(NG), Japan/Philippines **(NH)**.

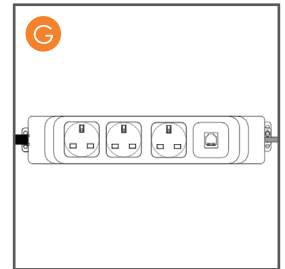

Netbox M
 (3 power socket + 1 Tel)
(NI-NL)
 * Available for standard Great
 Britain **(NI)**, China **(NJ)**, Australia
(NK), Japan/Philippines **(NL)**.



Flip Box (FB)



Modesty Panel (M)

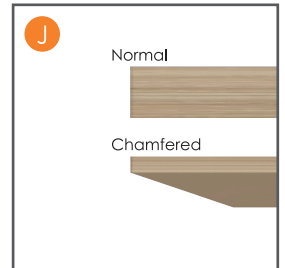
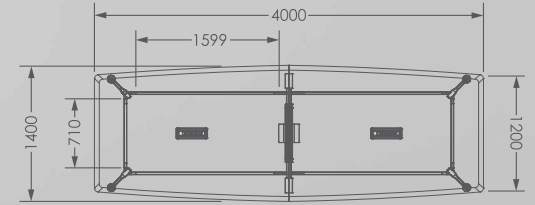

Table Top
 * Normal **(N)**
 * Chamfered **(C)**

MODUL CONFERENCE

Modul offers a wide range of solutions to organize meeting spaces. The wide range of materials, versatile configurations, sleek lines and technical solutions make Modul tables the perfect setting for discussions between teams and partners.



Tables Surface: White
Leg: Dull Chrome
Accessories: Wire console & Netbox Turn
Task Seating: BC-3

MODUL CONFERENCE

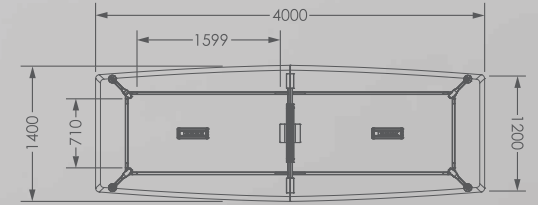

Tables Surface: White
Leg: Dull Chrome
Accessories: Wire console & Netbox Turn
Task Seating: BC-3

benithem®

MODUL
CONFERENCE

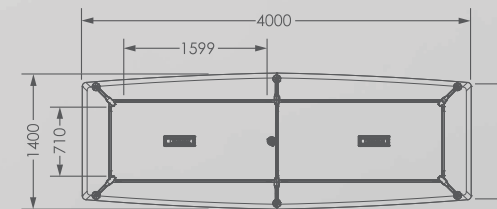

Tables Surface: Bavarian Beech
Leg: Dull Chrome
Accessories: Cable Snake & Netbox Turn

benithem[®]

MODUL
DISCUSSION TABLE

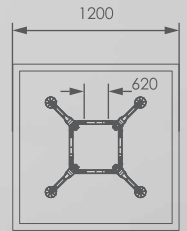

Tables Surface: Lendecor Walnut
Leg: Dull Chrome
Visitor Chair: B-Five

MODUL
CONFERENCE
 Optional Components

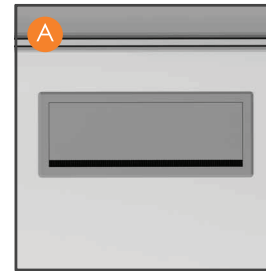
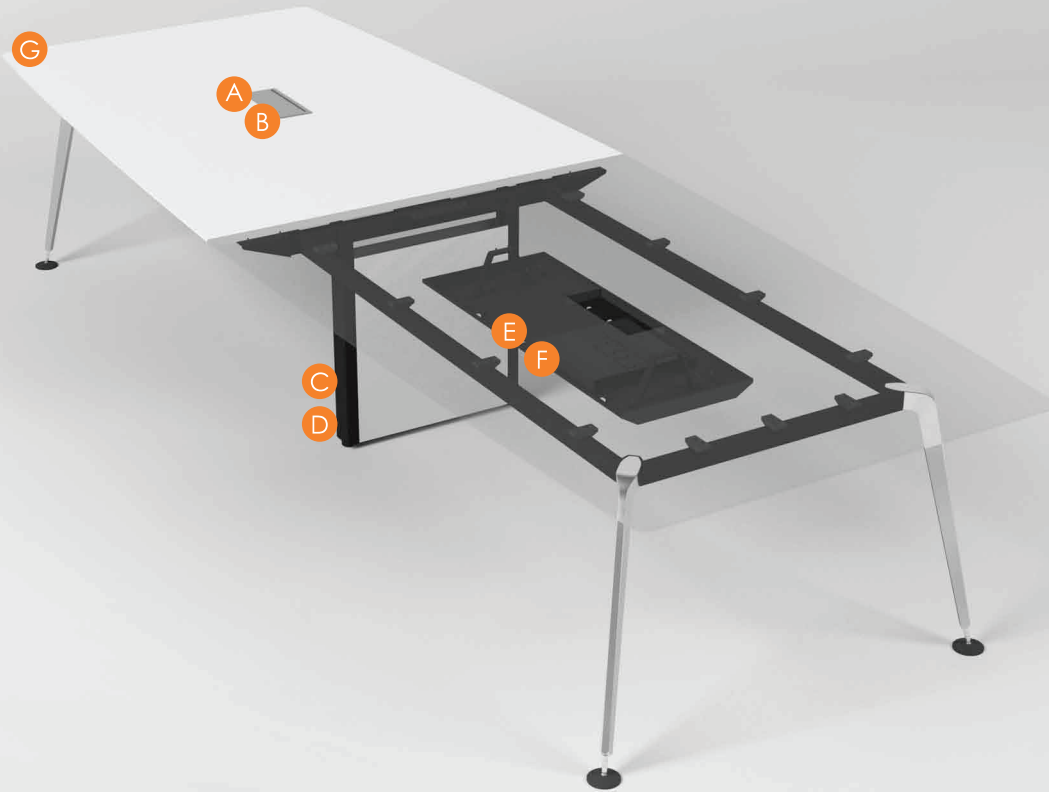

Flip Box (FB)

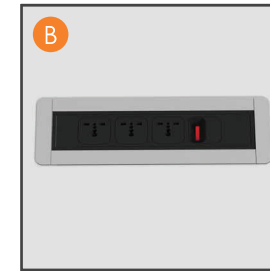

Netbox Turn
 (4 power socket) (N5-N8)
 * Available for standard Great Britain (N5), China (N6), Australia (N7), Japan/Philippines (N8).

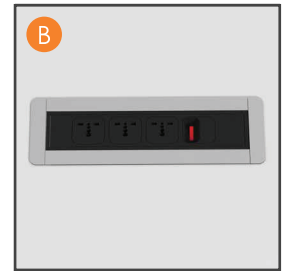

Netbox Turn
 (3 power socket + HDMI) (N1-N4)
 * Available for standard Great Britain (N1), China (N2), Australia (N3), Japan/Philippines (N4).

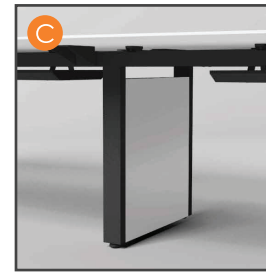

Wire Console (WC)
 * Not available for length 2400mm conference table.



Cable Snake (CS)



Wire Tray Include
 Tray Power Point (WTT)
 * Use for normal power socket

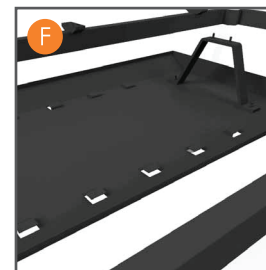

Wire Tray (WT)
 * Use for Netbox turn

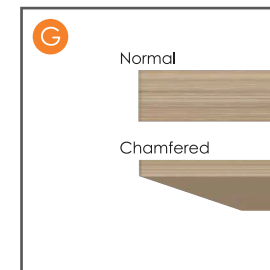
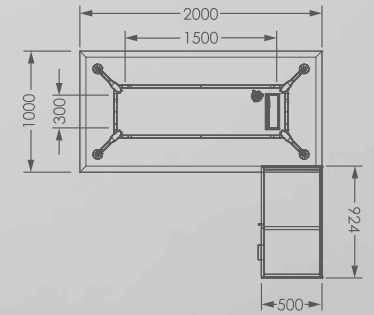

Table Top
 * Normal (N)
 * Chamfered (C)

MODUL EXECUTIVE

Decision making is one of the most critical task that an executive has to bear in his / her daily life. Therefore, an affable workplace will definitely be an important space for an executive.



Tables Surface: Rochelle White
Leg: Dull Chrome
Accessories: Cable Snake & Flip Box
Storage: MDL-Side Cabinet & MDL-Filling Cabinet
Executive Seating: Body
Modesty Panel: Arcylic

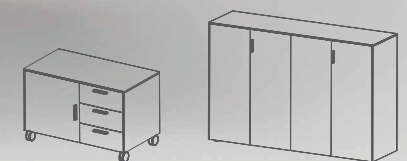

W 924
D 500
H 597

W 1824
D 500
H 1200

MODUL EXECUTIVE

Chamfered table tops matched with various color selections, shows the high level of quality of MODUL. The castor base provides the mobility which is often looked for in today's dynamic office. The matt acrylic modesty panel design shows the modern and contemporary sense of design.

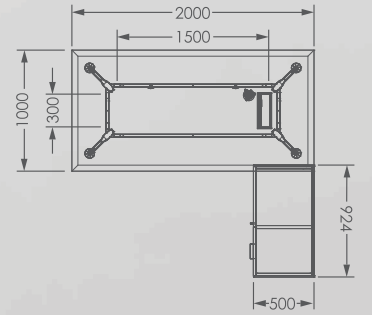

Tables Surface: Rochelle White
Leg: Dull Chrome
Accessories: Cable Snake & Flip Box
Storage: MDL-Side Cabinet
Executive Seating: Body
Modesty Panel: Acrylic

benithem[®]



W 924
D 500
H 597

MODUL
EXECUTIVE
Optional Components

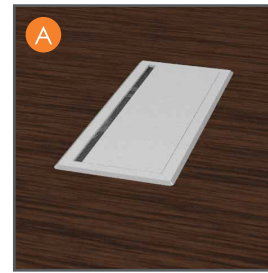

Flip Box **(FB)**

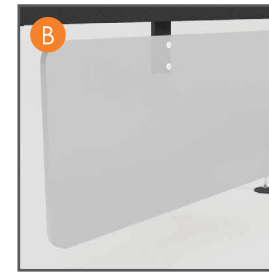

Acrylic Modesty Panel **(MA)**



MFC Modesty Panel **(MW)**

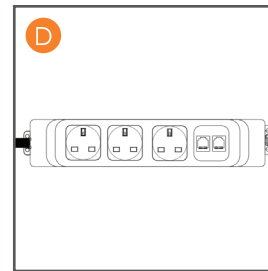

Netbox M
(3 power socket + 1 Data + 1 Tel) **(NA-ND)**
* Available for standard Great Britain **(NA)**, China **(NB)**, Australia **(NC)**, Japan/Philippines **(ND)**

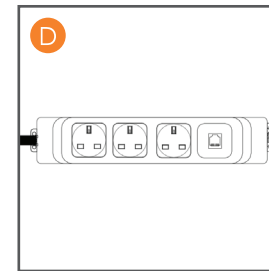

Netbox M
(3 power socket + 1 Data + 1 Tel) **(NE-NH)**
* Available for standard Great Britain **(NE)**, China **(NF)**, Australia **(NG)**, Japan/Philippines **(NH)**

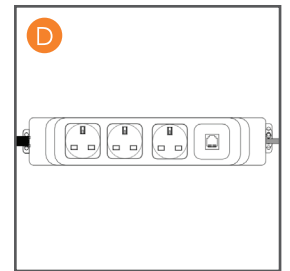

Netbox M
(3 power socket + 1 Tel) **(NI-NL)**
* Available for standard Great Britain **(NI)**, China **(NJ)**, Australia **(NK)**, Japan/Philippines **(NL)**

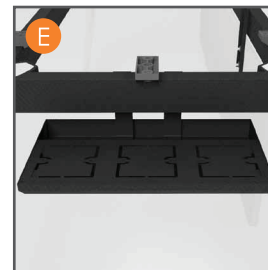

Wire Tray **(WT)**
* Available for normal power socket or Netbox M



Cable Snake **(CS)**

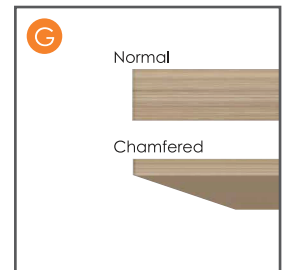
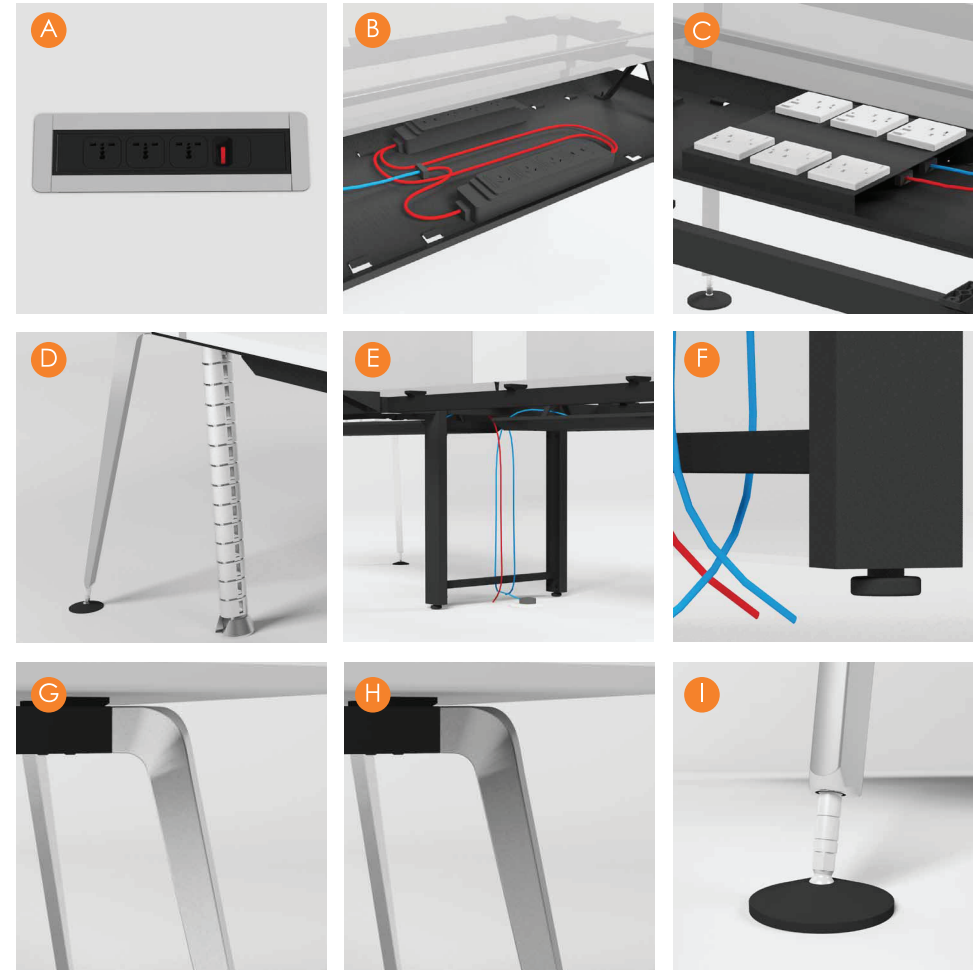
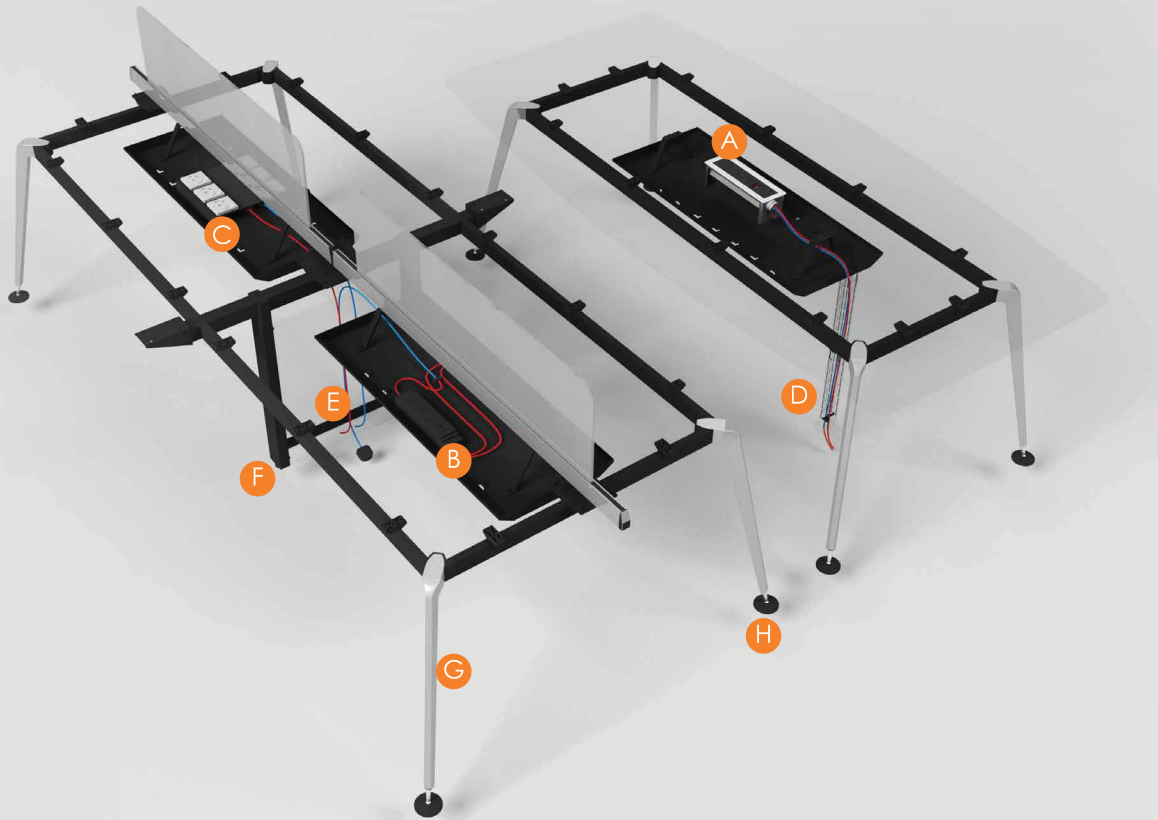

Table Top
* Normal **(N)**
* Chamfered **(C)**

MODUL

Features & Functions



- A.** Netbox Turn from AH Meyer are available for conference table, two type of Netbox Turn can be choose by user : 4 power socket or 3 power socket + 1 HDMI.
- B & C.** Two type of cable tray, user can use power socket of AH Meyer Netbox M (**Pic B**) or normal power socket (**Pic C**)
- D.** Cable snake can be choose for conference table for small amount of wire. Workstation cluster of 2 and Executive will also use cable snake for wire management.
- E.** Second wire management option of conference table for the user which having a big amount of wire, centre leg with wire console is the best selection. The centre leg is the indispensable components for workstation.
- F.** Centre leg also come with height adjustable glider to solve the problem of flooring.
- G & H.** Two type of table leg finishing: Dull Chrome or Silver powder coating.
- I.** Height adjustable glider can be adjust the height of table from 725mm(Australia Standard/Japan Standard) to 750mm.

MODUL
Color Selection



MDL-WHITE L101/L101S



MDL-(F)FOLKSTONE
202/202S



MDL-(Z)IVORY MAPLE
374/374S



MDL-ROCHELLE WHITE
3A7/3A7S



MDL-OLIVE ASH 3D4/3D4S

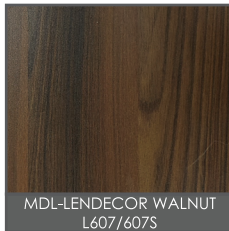

MDL-LENDECOR WALNUT
L607/607S



MDL-(E)BAVARIAN BEECH
324/324S



MDL-(B)BLACK 230/230S

- * Grade of Melamine Faced Chipboard is E2.
- * All worktop adhesive with 1.5mm PVC Edging (Matching color with worktop)
- * Thickness of worktop is 25mm

MODUL
Cabinet Selection

EXECUTIVE



MDL-MFC
MOBILE PEDESTAL



MDL-MFC
SIDE CABINET



MDL-MFC
FILLING CABINET

WORKSTATION



MDL-STEEL PEDESTAL PM 009



MDL-CADDY PM 007L



MDL-CADDY PM 007R



MDL-STEEL PEDESTAL PM 009
+
MDL-CUSHION TOP 400 X 500



MDL-CADDY PM 007L
+
MDL-CUSHION TOP 400 X 500











MDL-CADDY PM 007R
+
MDL-CUSHION TOP 400 X 500

- * Standard color of steel cabinet is white color.
- * Cushion top color please refer benithem fabric chart, categories B & C.

MODUL WORKSTATION
Product Code Combination

TABLE TOP TYPE

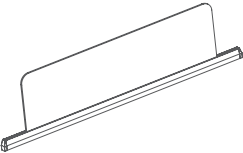
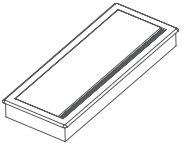
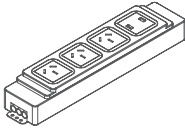
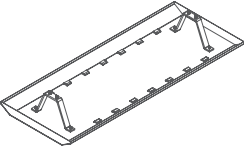
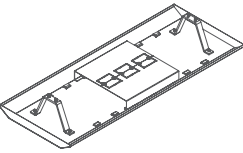
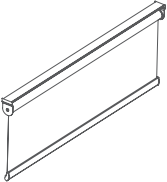
		(C) Chamfered
		(H) With hole of Flip Box
		(CH) Chamfered and with hole of Flip Box
		(N) Normal Without chamfered and without hole of Flip Box
		
SCREEN PANEL		
		
NETBOX M		
		
WIRE TRAY WITH TRAY OF POWERPOINT		
	MODESTY PANEL	

Product Name _____

(MDL) Modul _____

Leg Finishing _____

(DC) Dull Chrome _____

(S) Silver _____

(E) Epoxy _____

Product Type _____

(M) Manager _____

(C) Conference _____

(W) Workstation _____

(D) Discussion _____

Length of Table Top _____

(15) 1500 _____

(16) 1600 _____

(17) 1700 _____

(18) 1800 _____

Width of Table Top _____

(73) 737 _____

Seater _____

(2) Cluster of 2 _____

(4) Cluster of 4 _____

(6) Cluster of 6 _____

(8) Cluster of 8 _____

Table Top Type _____

(C) Chamfered _____

(H) With hole of Flip Box _____

(CH) Chamfered and with hole of Flip Box _____

(N) Normal (without chamfered and without hole of Flip Box) _____

(X) No table top _____

Screen Panel Type _____

(A) Acrylic _____

(F) Fabric _____

Flip Box _____

(FB) Flip Box _____

(FO) No Flip Box _____

Netbox M Type _____

(NA) 4 Gang (GB) + AMP RJ45 (Data) & AMP RJ11 (Tel) _____

(NB) 4 Gang (CN) + AMP RJ45 (Data) & AMP RJ11 (Tel) _____

(NC) 4 Gang (AUS) + AMP RJ45 (Data) & AMP RJ11 (Tel) _____

(ND) 4 Gang (JP/PH) + AMP RJ45 (Data) & AMP RJ11 (Tel) _____

(NE) 4 Gang (GB) + AMP RJ45 (Data) _____

(NF) 4 Gang (CN) + AMP RJ45 (Data) _____

(NG) 4 Gang (AUS) + AMP RJ45 (Data) _____

(NH) 4 Gang (JP/PH) + AMP RJ45 (Data) _____

(NI) 4 Gang (GB) + AMP RJ11 (Tel) _____

(NJ) 4 Gang (CN) + AMP RJ11 (Tel) _____

(NK) 4 Gang (AUS) + AMP RJ11 (Tel) _____

(NL) 4 Gang (JP/PH) + AMP RJ11 (Tel) _____

(NO) No Netbox M _____

Wire Tray _____

(WT) Wire Tray _____

(WTT) Wire Tray with tray of powerpoint _____

(WO) No Wire Tray _____











Modesty Panel _____

(M) Modesty Panel (Blind) _____

(O) No Modesty Panel _____

MODUL CONFERENCE
Product Code Combination

TABLE TOP TYPE

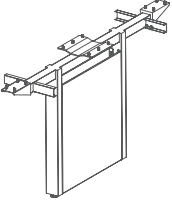
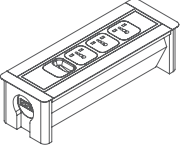
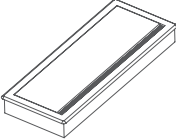
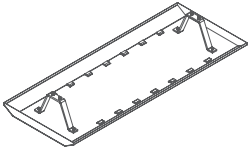
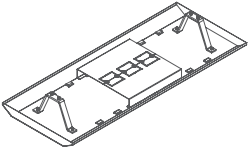
 (R) Rectangular	 (C) Chamfered	
	 (H) With hole of Netbox Turn (F) With hole of Flip Box	
 (BS) Boat Shape	 (CH) Chamfered and with hole of Netbox Turn (CF) Chamfered and with hole of Flip Box	
	 (N) Normal Without chamfered and without hole of Netbox Turn / Flip Box	
 CABLE SNAKE	 WIRE CONSOLE	
 NETBOX TURN	 FLIP BOX	
 WIRE TRAY	 WIRE TRAY WITH TRAY OF POWERPOINT	











MDL - DC - C 2412 - BS CH - CS N1 WT

Product Name _____
(MDL) Modul
 Leg Finishing _____
(DC) Dull Chrome
(S) Silver
(E) Epoxy
 Product Type _____
(M) Manager
(C) Conference
(W) Workstation
(D) Discussion
 Length & Width of Table Top _____
(2412) 2400 x 1200
(3213) 3200 x 1300
(4014) 4000 x 1400
(4814) 4800 x 1400
 Table Top Shape _____
(R) Rectangular
(BS) Boat Shape
 Table Top Type _____
(C) Chamfered
(H) With hole of Netbox Turn
(F) With hole of Flip Box
(CH) Chamfered and with hole of Netbox Turn
(CF) Chamfered and with hole of Flip Box
(N) Normal (without chamfered and without hole of Flip Box)
(X) No table top
 Wire Management Type _____
(CS) Cable Snake
(WC) Wire Console
 Powerpoint Type _____
(FB) Flip Box
(N1) Netbox Turn 3 Gang (GB) + HDMI
(N2) Netbox Turn 3 Gang (CN) + HDMI
(N3) Netbox Turn 3 Gang (AUS) + HDMI
(N4) Netbox Turn 3 Gang (JP/PH) + HDMI
(N5) Netbox Turn 4 Gang (GB)
(N6) Netbox Turn 4 Gang (CN)
(N7) Netbox Turn 4 Gang (AUS)
(N8) Netbox Turn 4 Gang (JP/PH)
(N0) No Flip Box / No Netbox Turn
 Wire Tray _____
(WT) Wire Tray
(WTT) Wire Tray with tray of powerpoint
(W0) No Wire Tray

MODUL EXECUTIVE
Product Code Combination

MDL - DC - M 1890 - CH - MA FB NA WT CS

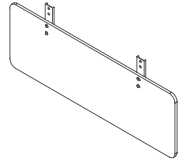
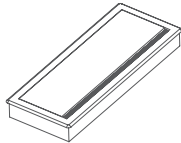
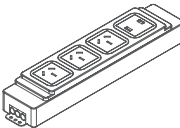
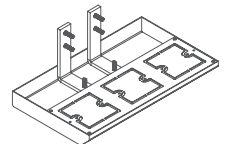
TABLE TOP TYPE

		(C) Chamfered
		(H) With hole of Flip Box
		(CH) Chamfered and with hole of Flip Box
		(N) Normal Without chamfered and without hole of Flip Box
		
MODESTY PANEL	FLIP BOX	
		
NETBOX M	WIRE TRAY	
		
CABLE SNAKE		

Product Name _____

(MDL) Modul _____

Leg Finishing _____

(DC) Dull Chrome _____

(S) Silver _____

(E) Epoxy _____

Product Type _____

(M) Manager _____

(C) Conference _____

(W) Workstation _____

(D) Discussion _____

Length & Width of Table Top _____

(1890) 1800 x 900 _____

(2010) 2000 x 1000 _____

Table Top Type _____

(C) Chamfered _____

(H) With hole of Flip Box _____

(CH) Chamfered and with hole of Flip Box _____

(N) Normal (without chamfered and without hole of Flip Box) _____

(X) No table top _____

Modesty Panel Type _____

(MA) Acrylic _____

(MW) MFC _____

(MO) No Modesty Panel _____

Flip Box _____

(FB) Flip Box _____

(FO) No Flip Box _____

Netbox M Type _____

(NA) 4 Gang (GB) + AMP RJ45 (Data) & AMP RJ11 (Tel) _____

(NB) 4 Gang (CN) + AMP RJ45 (Data) & AMP RJ11 (Tel) _____

(NC) 4 Gang (AUS) + AMP RJ45 (Data) & AMP RJ11 (Tel) _____

(ND) 4 Gang (JP/PH) + AMP RJ45 (Data) & AMP RJ11 (Tel) _____

(NE) 4 Gang (GB) + AMP RJ45 (Data) _____

(NF) 4 Gang (CN) + AMP RJ45 (Data) _____

(NG) 4 Gang (AUS) + AMP RJ45 (Data) _____

(NH) 4 Gang (JP/PH) + AMP RJ45 (Data) _____

(NI) 4 Gang (GB) + AMP RJ11 (Tel) _____

(NJ) 4 Gang (CN) + AMP RJ11 (Tel) _____

(NK) 4 Gang (AUS) + AMP RJ11 (Tel) _____

(NL) 4 Gang (JP/PH) + AMP RJ11 (Tel) _____

(NO) No Netbox M _____

Wire Tray _____

(WT) Wire Tray _____

(WO) No Wire Tray _____

Cable Snake _____





(CS) Cable Snake _____

(CO) No Cable Snake _____

MODUL DISCUSSION TABLE
Product Code Combination

MDL - DC - D 12- CH

TABLE TOP TYPE

		(C) Chamfered
		(N) Normal

Product Name _____
(MDL) Modul _____
 Leg Finishing _____
(DC) Dull Chrome _____
(S) Silver _____
(E) Epoxy _____
 Product Type _____
(M) Manager _____
(C) Conference _____
(W) Workstation _____
(D) Discussion _____
 Length of Table Top _____
(11) 1100 _____
(12) 1200 _____
(13) 1300 _____
 Table Top Type _____
(C) Chamfered _____
(N) Normal _____
(X) No table top _____

Let our Quality do the Talking...

benithem[®]

Benithem Sdn. Bhd.

PTD 10710, Jln Kg Air Putih, Jalan Sawah,
Mukim Jeram Batu, 81500 Pekan Nanas,
Pontian, Johor, West Malaysia.

T: 607-699 6668

F: 607-699 6886

E: sales@benithem.com

www.benithem.com



* Benithem reserves the rights to change the specifications without prior notification.

* Benithem products are manufactured under strict quality controls by Benithem Sdn Bhd, recipient of the ISO 9001:2015 quality assurance certification and ISO 14001:2015 environmental certification.